









<p>(A)</p>  <p>M6X50mm 8+1pcs</p>	<p>(B)</p>  <p>3.5X50mm 4+1pcs</p>	<p>(C)</p>  <p>3.5X30mm 8+1pcs</p>	
<p>(1)</p>  <p>1pc</p>	<p>(2)</p>  <p>1pc</p>	<p>(3)</p>  <p>1pc</p>	
<p>(4)</p>  <p>1pc</p>	<p>(5)</p>  <p>1pc</p>	<p>(6)</p>  <p>1pc</p>	
<p>(7)</p>  <p>2pcs</p>	<p>(8)</p>  <p>1pc</p>	<p>(9)</p>  <p>4pcs</p>	<p>(10)</p>  <p>1pc</p>

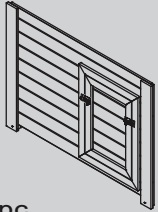
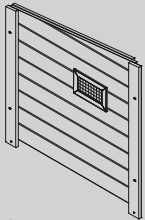
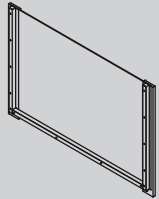
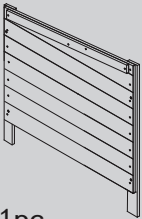
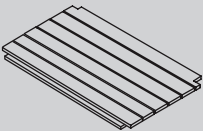
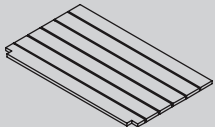

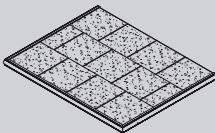
(DE) Um die Lebensdauer des Stalles zu verlängern, sollte das Holz mit geeignetem Anstrich nachbehandelt werden. Der beste Standplatz ist unter einem Vordach an der vom Wetter abgewandten Seite.

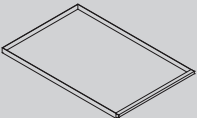
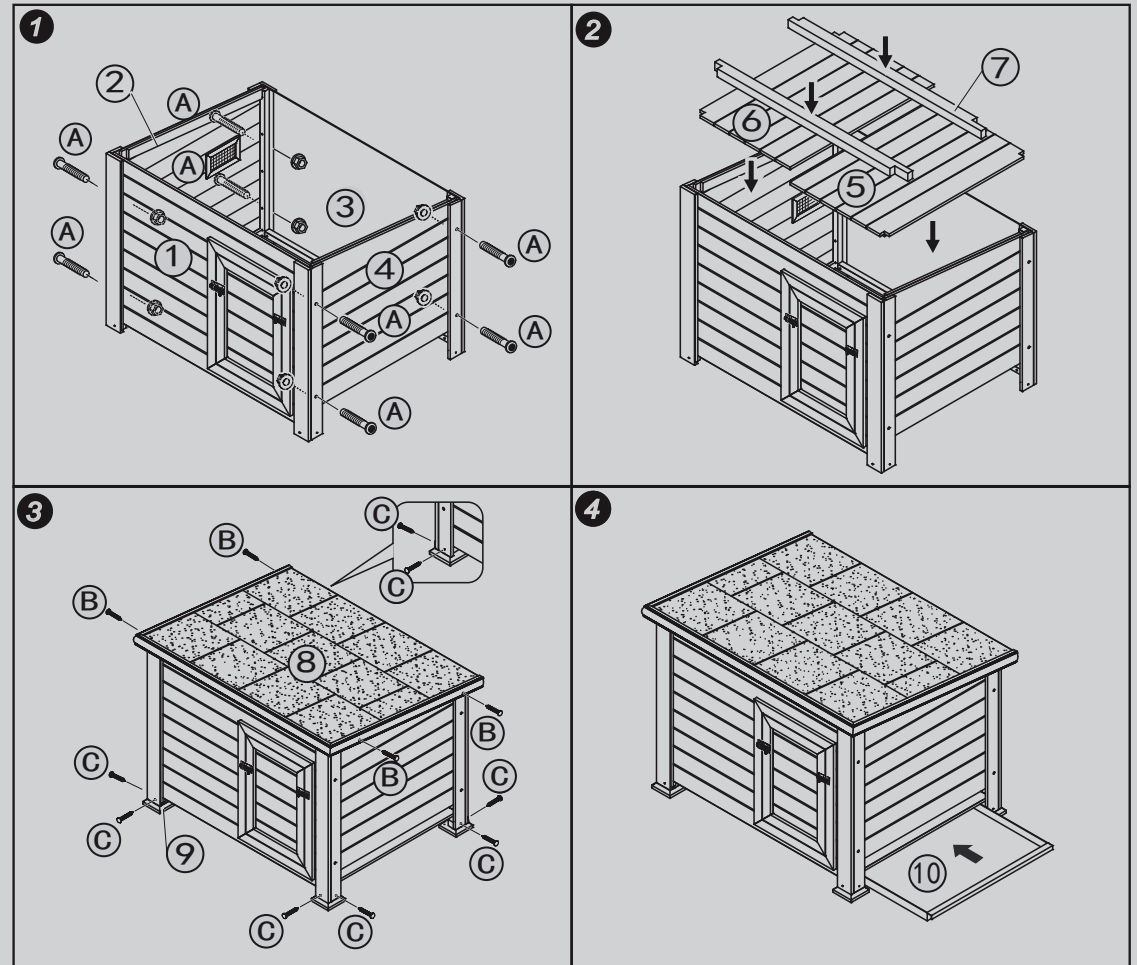
(FR) Pour augmenter la durée de vie de ce produit il convient de r e aliser un traitement complémentaire avec une teinture similaire . Un emplacement couvert, à l'abri des intempéries serait la meilleure implantation.

(EN) In order to enhance life expectancy it is advisable to treat the wood with an appropriate additional coating. Best place the hut under a porch to avoid direct exposure to the elements.

(IT) Per prolungare la vita della stalla bisogna ancora trattare il legno con una verniciatura adatta. La posizione ideale per la stalla è sotto una tettoia al lato della casa protetta dal maltempo.